

1 PRODUCT OVERVIEW

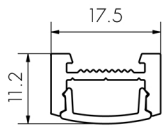

DOWNHILL DAN 10

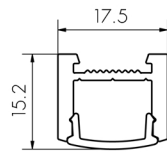

DOWNHILL DAN 14

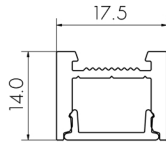

FLAT FREDDIE 14

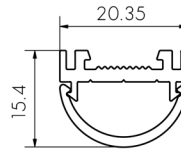

SIDWAYS SALLY 5C

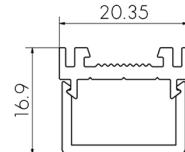

SIDWAYS SALLY 5R

2 AFFIX EXTRUSION TO SURFACE, MAKE ELECTRICAL CONNECTION

1. DRILL A 6MMØ HOLE FOR ELECTRICAL CABLE IN PLASTERBOARD.
2. SCREW FIX EXTRUSIONS USING 6GX32 CSK SCREWS (OR SIMILAR).
3. FEED LED STRIP TAILS (OR CABLE) THROUGH HOLE IN EXTRUSION AND CLAMP USING CORD GRIP (IF SUPPLIED). (SEE FIG. 1). DO NOT INSTALL LED STRIP AT THIS POINT.
4. MAKE ELECTRICAL CONNECTION: CONNECT LED STRIP TAILS TO LED DRIVER (SEE FIG. 2 IF SUPPLIED WITH MALE/FEMALE CONNECTORS).
5. IF USING MULTIPLE LENGTHS OF EXTRUSION, SLIDE EXTRUSIONS TOGETHER ON TO JOINER OR BEND PLATE.

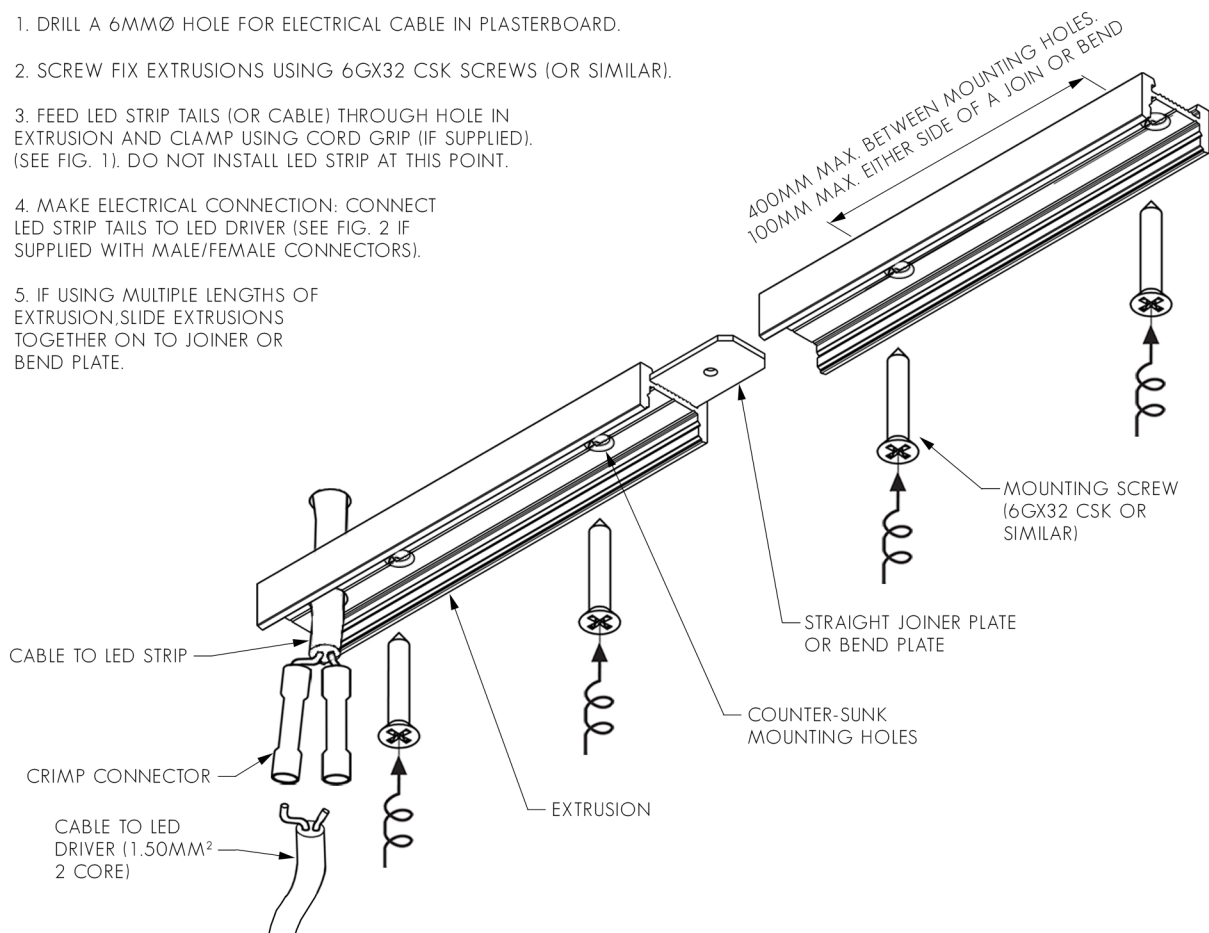

FIG. 1 - FASTEN CABLE USING CORD GRIP

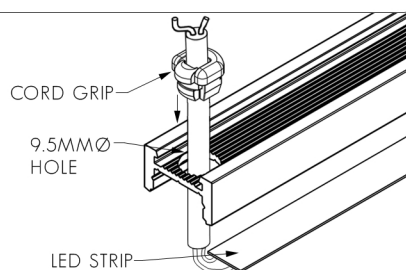

FIG. 2 - MAKE ELECTRICAL CONNECTION

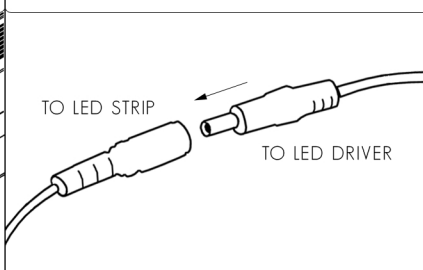
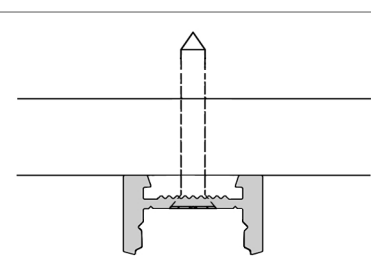

FIG. 3 - ENSURE EXTRUSION IS MOUNTED SECURELY



3

CLEAN EXTRUSION, INSTALL LED STRIP, DIFFUSER AND END CAPS

1. **IMPORTANT:** BEFORE MOUNTING LED STRIP, CLEAN EXTRUSION USING AN ALCOHOL BASED CLEANER.
2. REMOVE BACKING FROM LED STRIP TO EXPOSE STICKY SURFACE. LAY LED STRIP INTO EXTRUSION, USING THE SMALL GROOVES IN THE BACK OF THE EXTRUSION AS A GUIDE. USE A DAB OF SILICON AT EACH END OF THE LED STRIP TO PREVENT ENDS FROM LIFTING OFF EXTRUSION.
3. CLIP DIFFUSER INTO EXTRUSION, ENSURING A FIRM CONNECTION (SEE FIG. 4).
4. SLIDE END CAPS INTO ENDS OF EXTRUSION.

FIG. 4 - ENSURE DIFFUSER IS MOUNTED SECURELY

