

## 1

### PRODUCT OVERVIEW

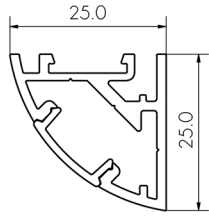

ANGLE ANDY 25

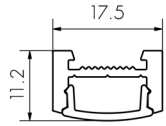

DOWNHILL DAN 10

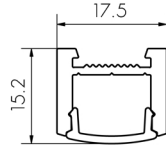

DOWNHILL DAN 14

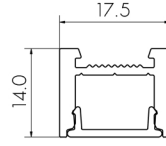

FLAT FREDDIE 14

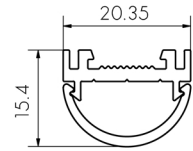

SIDEWAYS SALLY 5C

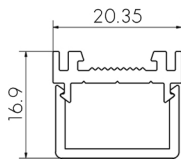

SIDEWAYS SALLY 5R

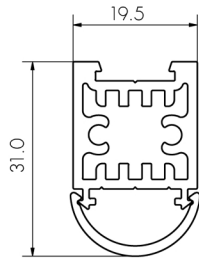

SIDEWAYS SALLY 20C

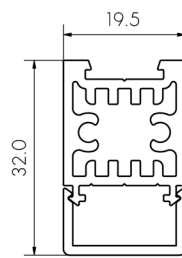

SIDEWAYS SALLY 20R

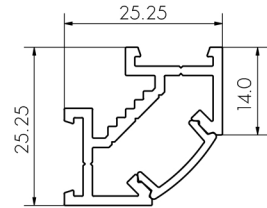

WHERE'S BEN 25

## 2

### DRAW A GUIDE LINE AND AFFIX JOINERY MOUNTING CLIPS TO SURFACE

1. DRAW A STRAIGHT LINE ON THE MOUNTING SURFACE FOR JOINERY MOUNTING CLIPS.
2. DRILL MOUNTING HOLES ON GUIDE LINE USING THE TWO OUTER HOLES OF THE JOINERY MOUNTING. IF RECESSING, SEE FIG. 1 BELOW.

**NOTE: MAXIMUM SPACE BETWEEN MOUNTING HOLES SHOULD BE 400MM. MOUNTING HOLES MUST BE DRILLED WITHIN 100MM OF EACH END AND WITHIN 100MM EITHER SIDE OF A JOIN OR BEND. E.G. A 1000MM EXTRUSION SHOULD HAVE 3 MOUNTING POINTS, ONE CENTRED AND ONE EACH END WITHIN 100MM.**

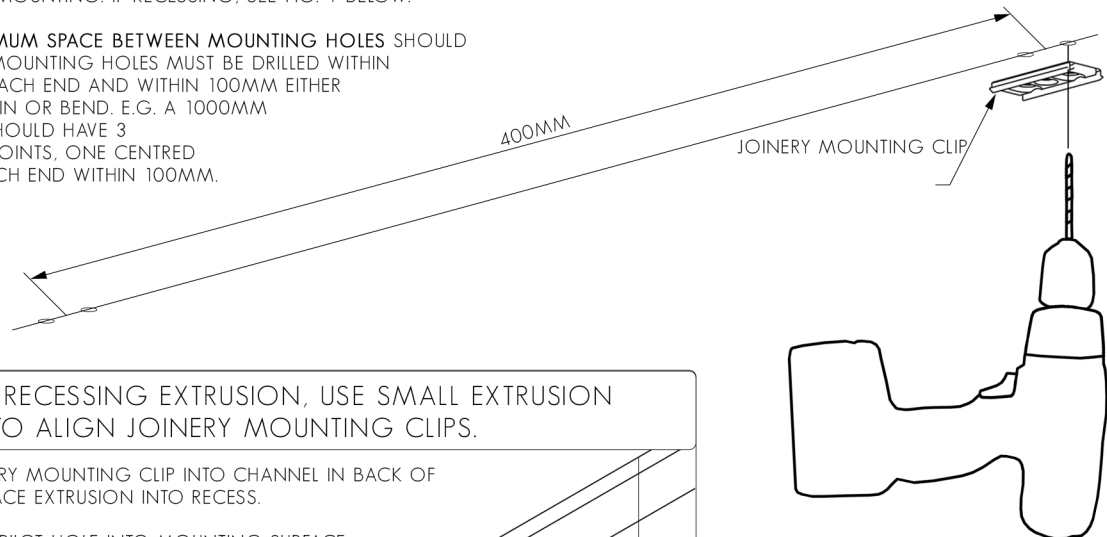
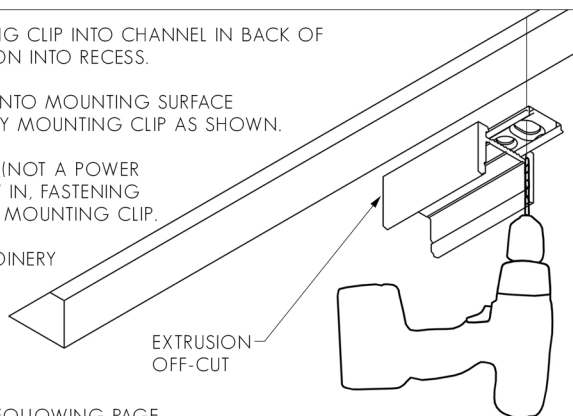

FIG. 1 - IF RECESSING EXTRUSION, USE SMALL EXTRUSION OFF-CUT TO ALIGN JOINERY MOUNTING CLIPS.

1. SLIDE JOINERY MOUNTING CLIP INTO CHANNEL IN BACK OF EXTRUSION. PLACE EXTRUSION INTO RECESS.
2. DRILL 2MM PILOT HOLE INTO MOUNTING SURFACE THROUGH HOLE IN JOINERY MOUNTING CLIP AS SHOWN.
3. USING A SCREW DRIVER (NOT A POWER DRILL), SCREW FIRST SCREW IN, FASTENING ONE END OF THE JOINERY MOUNTING CLIP.
4. SLIDE EXTRUSION OFF JOINERY MOUNTING CLIP, THEN SLIDE ON TO OTHER SIDE OF THE CLIP AND REPEAT STEPS 1 THROUGH TO 3.
5. GO TO STEP 3 ON THE FOLLOWING PAGE.



**WARNING: MOUNTING CLIPS ARE SUITABLE FOR JOINERY INSTALLATIONS ONLY. WHEN MOUNTING TO PLASTERBOARD, EXTRUSION MUST BE SCREW-FIXED. SEE ALTERNATIVE INSTRUCTIONS.**

**3** INSTALL JOINERY MOUNTING CLIPS, EXTRUSION AND MAKE ELECTRICAL CONNECTION.

1. DRILL A 6MMØ HOLE FOR ELECTRICAL CABLE IN JOINERY.
2. USING A SCREW DRIVER (NOT A POWER DRILL), SCREW JOINERY MOUNTING CLIPS IN USING PRE-DRILLED HOLES. **WARNING: DO NOT OVER-TIGHTEN.**
3. FEED LED STRIP TAILS (OR CABLE) THROUGH HOLE IN EXTRUSION AND CLAMP USING CORD GRIP (IF SUPPLIED) (SEE FIG. 2). DO NOT INSTALL LED STRIP AT THIS POINT.
4. MAKE ELECTRICAL CONNECTION: CONNECT LED STRIP TAILS TO LED DRIVER (SEE FIG. 3 IF SUPPLIED WITH MALE/FEMALE CONNECTORS).
5. CLIP EXTRUSION ON TO JOINERY MOUNTING CLIPS, ENSURING A FIRM CONNECTION (SEE FIG. 4).
6. IF USING MULTIPLE LENGTHS OF EXTRUSION, SLIDE EXTRUSIONS TOGETHER ON TO JOINER OR BEND PLATE.

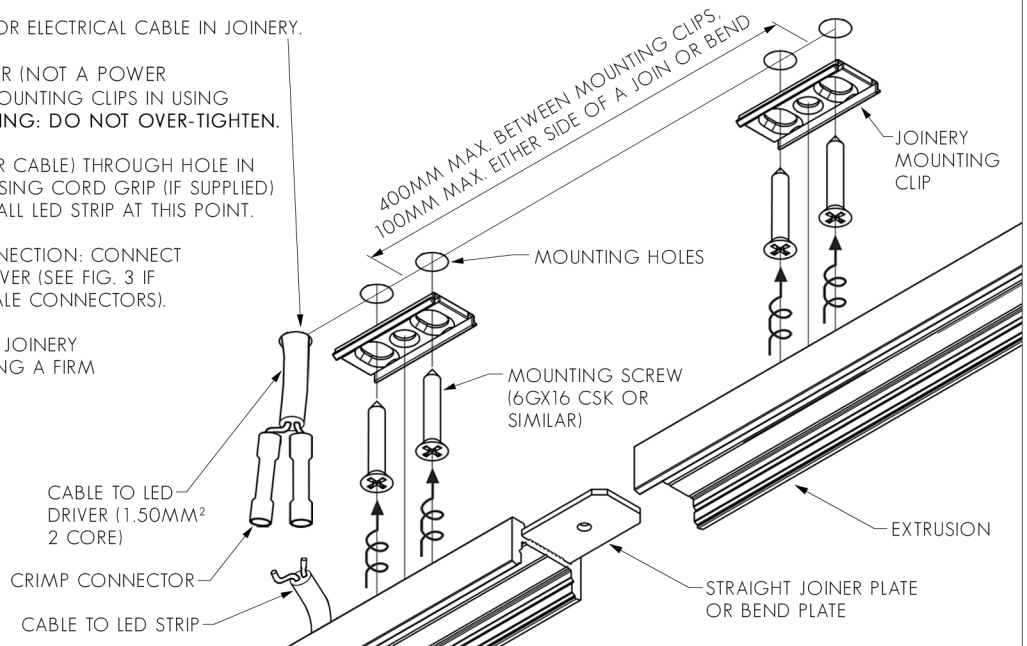

FIG. 2 - FASTEN CABLE USING CORD GRIP

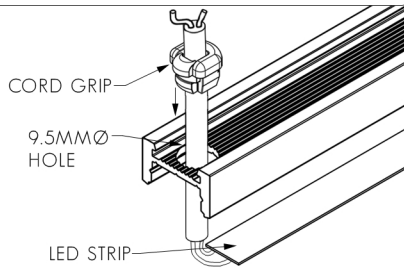

FIG. 3 - MAKE ELECTRICAL CONNECTION

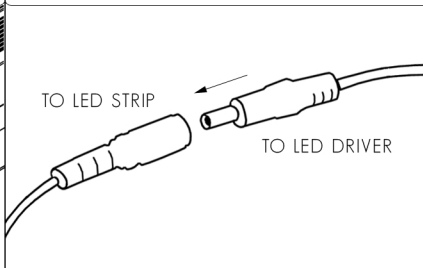
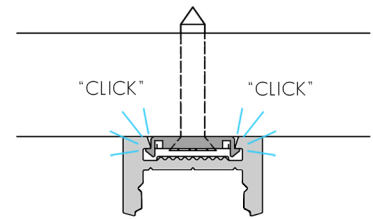

FIG. 4 - ENSURE EXTRUSION IS MOUNTED SECURELY



**4** CLEAN EXTRUSION, INSTALL LED STRIP, DIFFUSER AND END CAPS

1. **IMPORTANT:** BEFORE MOUNTING LED STRIP, CLEAN EXTRUSION USING AN ALCOHOL BASED CLEANER.
2. REMOVE BACKING FROM LED STRIP TO EXPOSE STICKY SURFACE. LAY LED STRIP INTO EXTRUSION. USING THE SMALL GROOVES IN THE BACK OF THE EXTRUSION AS A GUIDE. USE A DAB OF SILICON AT EACH END OF THE LED STRIP TO PREVENT ENDS FROM LIFTING OFF EXTRUSION.
3. CLIP DIFFUSER INTO EXTRUSION, ENSURING A FIRM CONNECTION (SEE FIG. 5).
4. SLIDE END CAPS INTO ENDS OF EXTRUSION.

FIG. 5 - ENSURE DIFFUSER IS MOUNTED SECURELY

